

# Deutsches Institut für Bautechnik

Anstalt des öffentlichen Rechts

Kolonnenstr. 30 I  
10829 Berlin  
Germany

Tel. +49(0)30 /87 30 0  
Fax +49(0)30 /87 30 320  
E-mail [dibt@dibt.de](mailto:dibt@dibt.de)  
Internet [www.dibt.de](http://www.dibt.de)



# DIBt

Mitglied der EOTA  
Member of EOTA

## European Technical Approval ETA-05/0267

English translation prepared by Dibt - Original version in German language

<b>Handelsbezeichnung</b> <i>Trade name</i>	<b>alfa Iso-Universaldübel IUD</b> <i>alfa Iso-Universalanchor IUD</i>
<b>Zulassungsinhaber</b> <i>Holder of approval</i>	<b>alfa Dübel GmbH</b> Braukämperstraße 101 45899 Gelsenkirchen
<b>Zulassungsgegenstand und Verwendungszweck</b> <i>Generic type and use of construction product</i>	<b>Schlagdübel zur Befestigung von außenseitigen Warmedämm- Verbundsystemen mit Putzschicht in Beton und Mauerwerk</b> <i>Nail-in plastic anchors for fixing of external thermal insulation composi- tions with rendering to concrete and masonry</i>
<b>Geltungsdauer</b> <i>Validity:</i>	<b>vom</b> <i>from</i> <b>14 February 2006</b> <b>bis</b> <i>to</i> <b>14 February 2011</b>
<b>Herstellwerk</b> <i>Manufacturing plant</i>	<b>alfa Dübel GmbH</b> Braukämperstraße 101 45899 Gelsenkirchen DEUTSCHLAND

**Diese Zulassung umfasst**  
*This Approval contains*

**15 Seiten einschließlich 7 Anhänge**  
*15 pages including 7 annexes*



Europäische Organisation für Technische Zulassungen  
European Organisation for Technical Approvals

## **I LEGAL BASES AND GENERAL CONDITIONS**

- 1 This European Technical Approval is issued by Deutsches Institut für Bautechnik in accordance with
  - Council Directive 89/106/EEC of 21 December 1988 on the approximation of laws, regulations and administrative provisions of Member States relating to construction products<sup>1</sup>, modified by Council Directive 93/68/EEC<sup>2</sup> and Regulation (EC) N 1882/2003 of the European Parliament and of the Council<sup>3</sup>,  
Gesetz über das In-Verkehr-Bringen von und den freien Warenverkehr mit Bauprodukten zur Umsetzung der Richtlinie 89/106/EWG des Rates vom 21. Dezember 1988 zur Angleichung der Rechts- und Verwaltungsvorschriften der Mitgliedstaaten über Bauprodukte und anderer Rechtsakte der Europäischen Gemeinschaften (Bauproduktengesetz - BauPG) vom 28. April 1998<sup>4</sup> zuletzt geändert durch Gesetz vom (last amended by law on) 06.01.2004<sup>5</sup>,
  - Common Procedural Rules for Requesting, Preparing and the Granting of European Technical Approvals set out in the Annex to Commission Decision 94/23/EC<sup>6</sup>,
  - Guideline "Plastic anchors for fixing of external thermal insulation composite systems with rendering", ETAG 014
- 2 Deutsches Institut für Bautechnik is authorized to check whether the provisions of this European Technical Approval are met. Checking may take place in the manufacturing plant. Nevertheless, the responsibility for the conformity of the products to the European Technical Approval and for their fitness for the intended use remains with the holder of the European Technical Approval
- 3 This European Technical Approval is not to be transferred to manufacturers or agents of manufacturers other than those indicated on page 1, or manufacturing plants other than those indicated on page 1 of this European Technical Approval
- 4 This European Technical Approval may be withdrawn by Deutsches Institut für Bautechnik, in particular pursuant to information by the Commission according to Article 5(1) of Council Directive 89/106/EEC.
- 5 Reproduction of this European Technical Approval including transmission by electronic means shall be in full. However, partial reproduction can be made with the written consent of Deutsches Institut für Bautechnik. In this case partial reproduction has to be designated as such. Texts and drawings of advertising brochures shall not contradict or misuse the European Technical Approval
- 6 The European Technical Approval is issued by the approval body in its official language. This version corresponds fully to the version circulated in EOTA. Translations into other languages have to be designated as such.

1 Official Journal of the European Communities N° L 40, 11 2 1989, p. 12

2 Official Journal of the European Communities N° L 220, 30 8 1993, p. 1

3 Official Journal of the European Union N° L 284, 31 10 2003, p. 25

4 Bundesgesetzblatt I, p. 812

5 Bundesgesetzblatt I, p. 2, 15

6 Official Journal of the European Communities N° L 17, 20 1 1994, p. 34

## **II SPECIFIC CONDITIONS OF THE EUROPEAN TECHNICAL APPROVAL**

### **1 Definition of product and intended use**

#### **1.1 Definition of the construction product**

The alpha nailed in anchor type IUD with a plate consists of a plastic part made of polyethylene and an accompanying specific nail of galvanised steel with an integrally moulded plastic head out of polyamide

The anchor may in addition be combined with the anchor plates IUS 140, IUS 110 or IUS 90 made from polyethylene

The installed anchor is shown in Annex 1

#### **1.2 Intended use**

The anchor is intended to be used for anchorages for which requirements for safety in use in the sense of the Essential Requirement 4 of Council Directive 89/106/EEC shall be fulfilled and failure of anchorages made with these products would cause low risk to human life. The anchor is to be used only as multiple fixing for the anchorage of bonded thermal insulation composite systems (ETICS) according to ETAG 004 in concrete and masonry. The base material shall consist of reinforced or unreinforced normal weight concrete of strength class C12/15 at minimum and C50/60 at maximum according to EN 206-1:2000-12 or masonry walls according to Table 4 Annex 4.

The anchor may only be used for transmission of wind suction loads and shall not be used for the transmission of dead loads of the thermal insulation composite system. The dead loads have to be transmitted by the bonding of the thermal insulation composite system

The provisions made in this European Technical Approval are based on an assumed working life of the anchor of 25 years. The indications given on the working life cannot be interpreted as a guarantee given by the producer, but are to be regarded only as a means for choosing the right products in relation to the expected economically reasonable working life of the works.

### **2 Characteristics of product and methods of verification**

#### **2.1 Characteristics of product**

The anchor corresponds to the drawings and information given in Annex 2. The characteristic material values, dimensions and tolerances of the anchor not given in these Annexes shall correspond to the respective values laid down in the technical documentation<sup>7</sup> of this European Technical Approval

The characteristic values for the design of the anchorages are given in Annex 4

Each anchor is to be marked with the name of the producer, the type and the length of the anchor.

The minimum effective anchorage depth shall be marked.

The anchor shall only be packaged and supplied as a complete unit.

<sup>7</sup> The technical documentation of this European Technical Approval is deposited at the Deutsches Institut für Bautechnik and, as far as relevant for the tasks of the approved bodies involved in the attestation of conformity procedure, is handed over to the approved bodies.

## 2.2 Methods of verification

The assessment of the fitness of the anchor for the intended use in relation to the requirements for safety in use in the sense of the Essential Requirement 4 has been made in compliance with the Guideline for European Technical Approval of "Plastic Anchors for Fixing of External Thermal Insulation Composite Systems with Rendering" ETAG 014, based on the use categories A, B and C.

In addition to the specific clauses relating to dangerous substances contained in this European Technical Approval, there may be other requirements applicable to the products falling within its scope (e.g. transposed European legislation and national laws, regulations and administrative provisions). In order to meet the provisions of the Construction Products Directive, these requirements need also to be complied with, when and where they apply.

## 3 Evaluation and attestation of conformity and CE marking

### 3.1 System of attestation of conformity

According to the decision 97/463/EG of the European Commission<sup>8</sup> the system 2(ii) (referred to as system 2+) of attestation of conformity applies.

This system of attestation of conformity is defined as follows.

System 2+ Declaration of conformity of the product by the manufacturer on the basis of:

(a) Tasks for the manufacturer:

- (1) initial type-testing of the product;
- (2) factory production control;
- (3) testing of samples taken at the factory in accordance with a prescribed test plan.

(b) Tasks for the approved body:

- (4) certification of factory production control on the basis of:
  - initial inspection of factory and of factory production control;
  - continuous surveillance, assessment and approval of factory production control.

### 3.2 Responsibilities

#### 3.2.1 Tasks of the manufacturer

##### 3.2.1.1 Factory production control

The manufacturer shall exercise permanent internal control of production. All the elements, requirements and provisions adopted by the manufacturer shall be documented in a systematic manner in the form of written policies and procedures, including records of results performed. This production control system shall insure that the product is in conformity with this European Technical Approval.

The manufacturer may only use raw materials stated in the technical documentation of this European Technical Approval.

The factory production control shall be in accordance with the control plan of 14 February 2006 which is part of the technical documentation of this European Technical Approval. The control plan is laid down in the context of the factory production control system operated by the manufacturer and deposited at Deutsches Institut für Bautechnik.<sup>9</sup>

<sup>8</sup> Official Journal of the European Communities L 198 of 25.07.1997

<sup>9</sup> The control plan is a confidential part of the documentation of the European Technical Approval, but not published together with the ETA and only handed over to the approved body involved in the procedure of attestation of conformity.  
See section 3.2.2.

The results of factory production control shall be recorded and evaluated in accordance with the provisions of the control plan.

#### 3.2.1.2 Other tasks of manufacturer

The manufacturer shall, on the basis of a contract, involve a body which is approved for the tasks referred to in section 3.1 in the field of anchors in order to undertake the actions laid down in section 3.2.2. For this purpose, the control plan referred to in sections 3.2.1.1 and 3.2.2 shall be handed over by the manufacturer to the approved body involved.

The manufacturer shall make a declaration of conformity stating that the construction product is in conformity with the provisions of this European Technical Approval.

#### 3.2.2 Tasks of approved bodies

The approved body shall perform the

- initial inspection of factory and of factory production control,
- continuous surveillance, assessment and approval of factory production control,

in accordance with the provisions laid down in the control plan.

The approved body shall retain the essential points of its actions referred to above and state the results obtained and conclusions drawn in a written report.

The approved certification body involved by the manufacturer shall issue an EC certificate of conformity of the factory production control stating the conformity with the factory production control of this European Technical Approval.

In cases where the provisions of the European Technical Approval and its control plan are no longer fulfilled the certification body shall withdraw the certificate of conformity and inform Deutsches Institut für Bautechnik without delay.

### 3.3 CE marking

The CE marking shall be affixed on each packaging of the anchor. The letters "CE" shall be followed by the identification number of the approved certification body, where relevant, and be accompanied by the following additional information:

- the name and address of the producer (legal entity responsible for the manufacturer),
- the last two digits of the year in which the CE marking was affixed,
- the number of the EC certificate for the factory production control,
- the number of the European Technical Approval,
- the number of the guideline for European Technical Approval,
- use categories A, B and C.

## 4 Assumptions under which the fitness of the product for the intended use was favourably assessed

### 4.1 Manufacturing

The European Technical Approval is issued for the product on the basis of agreed data/information, deposited with Deutsches Institut für Bautechnik, which identifies the product that has been assessed and judged. Changes to the product or production process, which could result in this deposited data/information being incorrect, should be notified to Deutsches Institut für Bautechnik before the changes are introduced. Deutsches Institut für Bautechnik will decide whether or not such changes affect the ETA and consequently the validity of the CE marking on the basis of the ETA and if so whether further assessment or alterations to the ETA shall be necessary.

## 4.2 Installation

### 4.2.1 Design of anchorages

#### 4.2.1.1 General

The FTA only applies to the manufacture and use of the anchor. Verification of stability of the external thermal insulation composite system including application of loads on the anchor and on the additional plate are not subject of this European Technical Approval.

Fitness for the intended use of the anchor is given under the following conditions:

The design of anchorages is carried out in compliance with ETAG 014 "Guideline for European Technical Approval of Plastic Anchors for Fixing of External Thermal Insulation Composite Systems with Rendering" under the responsibility of an engineer experienced in anchorages.

Verifiable calculation notes and drawings shall be prepared taking account of the loads to be anchored, the nature and strength of the base materials, the thickness of insulation and the dimensions of the anchorage members as well as of the relevant tolerances.

Proof of direct local application of load on the base material has been delivered.

The anchor shall only be used for the transmission of wind suction loads. All other loads such as dead load and restraints shall be transmitted by the adhesion of the relevant external thermal insulation composite system.

#### 4.2.1.2 Resistance

The characteristic values of the tension resistance of the anchor are given in Table 4, Annex 4. If there is a difference in the characteristic values of the base material according to Table 4 or a similar base material of category B and C is supposed to be used, job-site tests according to 4.2.3 shall be carried out and the characteristic tension resistance shall be determined.

#### 4.2.1.3 Characteristic values, spacing and dimensions of anchorage member

The minimum spacing and dimensions of anchorage member according to Annex 5 shall be observed.

#### 4.2.1.4 Displacement behaviour

When loaded to the design value of resistance in masonry made of sand-lime solid bricks a displacement of approximately 1,3 mm, in normal weight concrete and in masonry made of clay bricks a displacement of approximately 1,0 mm, in masonry made of vertically perforated clay bricks and sand-lime perforated bricks a displacement of approximately 0,8 mm and in masonry made of lightweight concrete solid blocks and lightweight concrete hollow blocks a displacement of approximately 0,5 mm in load direction is expected.

### 4.2.2 Installation of anchor

The fitness for use of the anchor can only be assumed if the following conditions of installation are met:

Anchor installation carried out by appropriately qualified personnel under the supervision of the person responsible for technical matters on site.

Use of the anchor only as supplied by the manufacturer without exchanging any component of the anchor.

Anchor installation in accordance with the manufacturer's specifications and drawings using the tools indicated in this European Technical Approval.

Checks before placing the anchor, to ensure that the characteristic values of the base material in which the anchor is to be placed is identical with the values which the characteristic loads apply for

Observation of the drill method (Drill holes in masonry made of vertically perforated clay bricks, lightweight concrete solid blocks and lightweight concrete hollow blocks may only be drilled using the rotary drill. Other drilling methods may also be used if job site tests according to 4.2.3 evaluate the influence of hammer or impact drilling.)

Placing drill holes without damaging the reinforcement.

Temperature during installation of the anchor : 0 °C

#### 4.2.3 Job site tests

The characteristic tension resistance of the anchor may be determined by means of job site pull-out tests carried out on the material actually used, if a characteristic resistance of the base material does not exist (for example masonry made of other solid masonry units, hollow or perforated bricks, hollow blocks)

The characteristic resistance of the anchor shall be determined by carrying out at least 15 centric tension load pull-out tests on site. These tests are also possible under the same conditions in a laboratory

Execution and evaluation of the tests as well as the issue of the test report and the determination of the characteristic resistance should be under the responsibility of approved testing laboratories or the supervision of the person responsible for the execution of the works on site.

Number and position of the anchors to be tested shall be adapted to the relevant special conditions of the site and, for example, to be increased in the case of hidden and larger areas, such that reliable information about the characteristic resistance of the anchor in the base material in question can be derived. The tests shall take into account the most unfavourable conditions of the practical execution.

##### 4.2.3.1 Assembly

The anchor to be tested shall be installed (e.g. preparation of drill hole, drilling tool to be used, drill bit) and the spacing and the edge distances shall be in the same way as planned for the fixing of the external thermal insulation composite system

Depending on the drilling tool and according to ISO 5468, hard metal hammer-drill bits or hard metal percussion drill bits, respectively, shall be used. The cutting diameter shall be at the upper tolerance limit

##### 4.2.3.2 Execution of test

The test rig used for the pull out tests shall provide a continuous slow increase of the load, controlled by a calibrated load cell. The load shall apply perpendicular to the surface of the base material and shall be transmitted to the anchor via an hinge. The reaction forces shall be transmitted into the base material at a distance of at least 15 cm from the anchor. The load shall be increased continuously in a way, that the ultimate load is reached after about 1 minute. The load is measured when the ultimate load ( $N_T$ ) is achieved.

##### 4.2.3.3 Test report

The test report shall include all information necessary to assess the resistance of the tested anchor. It shall be included in the construction dossier.

The minimum data required are:

- Construction site, owner of building; date and location of the tests, air temperature, type of member (ETICS) to be fixed.
- Masonry (type of brick, strength class, all dimensions of bricks, mortar group), Visual assessment of masonry (flush joints, joint clearance, regularity).
- Plastic anchor and nail: value of the cutting diameter of hard metal hammer-drill bits, measured before and after drilling.
- Test rig, results of tests including the indication of value  $N_1$
- Tests carried out or supervised by; signature

#### 4.2.3.4 Evaluation of test results

The characteristic resistance  $N_{Rk1}$  is obtained from the measured values of  $N_1$  as follows

$$N_{Rk1} = 0,6 \cdot N_1 \cdot 1,5 \text{ kN}$$

$N_1$  = the mean value of the five smallest measured values at the ultimate load

#### 4.2.4 Responsibility of the manufacturer

It is in the responsibility of the manufacturer to ensure that the information on the specific conditions according to 1 and 2 including Annexes referred to 4.2.1, 4.2.2 and 5 is given to those who are concerned. This information may be made by reproduction of the respective parts of the European Technical Approval. In addition, all installation data shall be shown clearly on the packaging and/or on an enclosed instruction sheet, preferably using illustrations.

The minimum data required are:

- base material for the intended use,
- drill bit diameter,
- maximum thickness of the ETICS,
- minimum effective anchorage depth,
- minimum hole depth,
- information on the installation procedure,
- identification of the manufacturing batch.

All data shall be presented in a clear and explicit form

## 5 Recommendations for the manufacturer

### 5.1 Recommendations on packaging, transport and storage

The anchor shall only be packaged and supplied as a complete unit

The anchor shall be stored under normal climatic conditions in its original light-proof packaging. Before installation, it shall not be extremely dried nor frozen.

In Vertretung  
Dipl.-Ing. Seyfert

*beglaubigt*  
Scheller

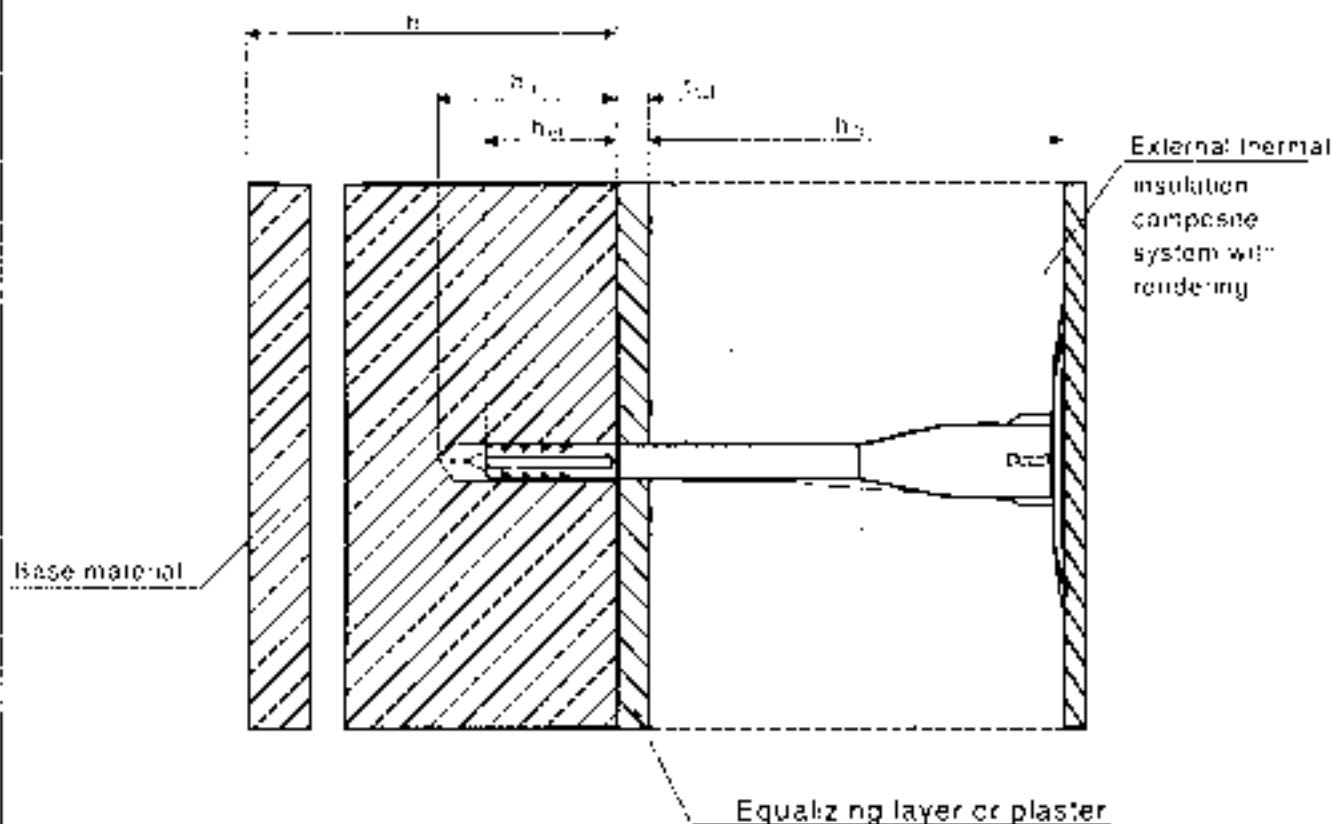

**Intended Use**

- Fixing of external thermal insulation composite systems in concrete and masonry

**Legend:**

- $h_i$  = thickness of insulation material
- $h_{eff}$  = effective anchorage depth
- $h$  = thickness of base material
- $h_{dr}$  = depth of drill hole in base material
- $t_{eq}$  = thickness of equalizing layer or non load bearing coating

**alfa Iso - Universalanchor IUD**

**Annex 1**

**Intended use**

of European  
Technical Approval  
ETA-05/0267

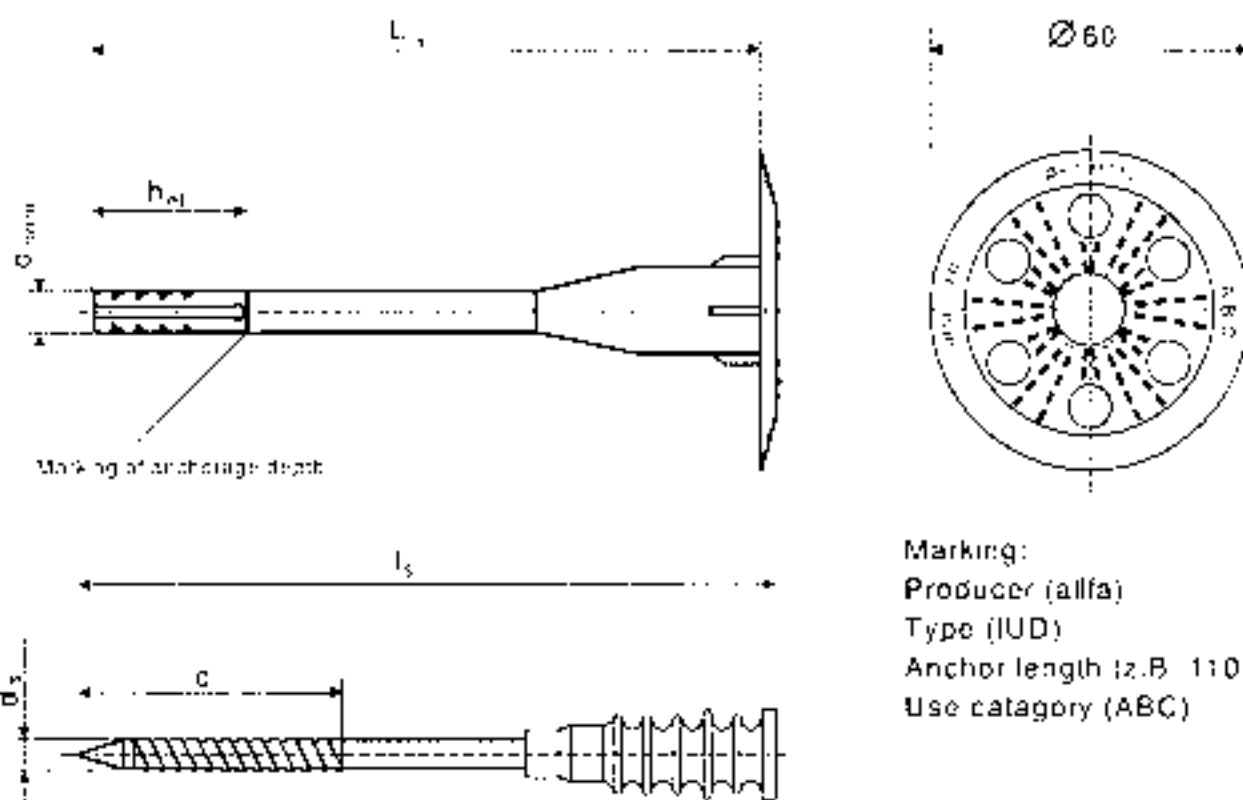

Marking:  
 Producer (alfa)  
 Type (IUD)  
 Anchor length (z.B. 110)  
 Use category (ABC)

Nail with an integrally moulded plastic head (PA)

Table 1: Dimensions

Anchor type	Anchor sleeve				Nail	
	$d_{\text{IUD}}$	$h_{\text{el}}$	$l_{\text{an}}$	$l_{\text{max}}$	$d_s$	$c$
alfa IUD	8	30	90	240	5.2	45
possible colours	natural, white, grey, blue, orange, red and green					

Determination of maximum thickness of insulation material  $h_D$   
 z.B.:  $f_D = L_s - l_{\text{an}} - h_{\text{el}}$  ( $L_s = \text{z.B. } 90; l_{\text{an}} = 10$ )  
 $f_D = 90 - 10 - 30$   
 $f_{D, \text{max}} = 50$

alfa Iso - Universalanchor IUD

Annex 2

Anchor type and dimensions

of European  
 Technical Approval  
 ETA-05-0267

Table 2: Materials

Designation	Material
Anchor sleeve with plate	Polyethylene, Hostalen GF 4750
Nail	Steel ( $f_{yk} \geq 345 \text{ N/mm}^2$ ; $f_{yk} > 210 \text{ N/mm}^2$ ) electr. galv. Zn $> 5 \mu\text{m}$ acc to EN ISO 4042 yellow or blue chromated
Moulded plastic head	Polyamide 6.0 Wekamid B 280 L grau. 2656/1

Table 3: Installation characteristics

Anchor type	alfa IUD		
Nominal diameter of drill bit	$d_d$	[mm]	8
Cutting diameter of drill bit	$d_{cut}$	[mm] $\leq$	8,45
Depth of drill hole	$h_d$	[mm] $\geq$	40
Effective anchorage depth	$h_{pe}$	[mm] $\geq$	30

**alfa Iso - Universalanchor IUD****Annex 3**

Materials, installation characteristics

of European  
Technical Approval

ETA-05/0267

Table 4: Characteristic resistance  $N_{Rk}$  in [kN] to tension loads in concrete and masonry for a single anchor

Anchor type	Base materials	Bulk density class [kg/dm <sup>3</sup> ]	Compressive strength f <sub>c</sub> [N/mm <sup>2</sup> ]	Remarks	alfa IUD	
					Dist. method	NRK [kN]
	Normal weight concrete C 12/15 (EN 206)				hammer	0,9
	Normal weight concrete ≥ C 16/20 (EN 206)				hammer	1,2
	Normal weight concrete C 50/60 (EN 206)				hammer	1,5
	Solid calcium silicate brick KS 12 (DIN 106)	≥ 1,8	≥ 12	Cross section reduced up to 15% by perforation vertically to the resting area	hammer	1,5
	Solid clay brick Mz 12 (DIN 105)	≥ 2,0	> 12	Cross section reduced up to 15% by perforation vertically to the resting area	hammer	0,9
	Vertically perforated calcium silicate brick KSL 12 (DIN 106)	≥ 1,4	≥ 12	Cross section reduced more than 15% by perforation vertically to the resting area. Exterior web thickness ≥ 24 mm	hammer	0,75
	Vertically perforated clay brick H 2 12 (DIN 105)	≥ 1,0	≥ 12	Cross section reduced between 15% and 50% by perforation vertically to the resting area. Exterior web thickness ≥ 14 mm	rotary	0,6
	Vertically perforated clay brick H 2 12 (Dormo 96124)	≥ 1,0	≥ 12	Cross section reduced between 15% and 50% by perforation vertically to the resting area. Exterior web thickness ≥ 10,3 mm see Annex 6	rotary	0,6
	Lightweight concrete block Vbl 4 (DIN 18152)	≥ 0,9	≥ 4	see Annex 6	rotary	2,4
	Lightweight concrete hollow block Hb 2 (DIN 18152)	≥ 0,7	≥ 2	see Annex 6	rotary	0,5
	Partial safety factor				γ <sub>m</sub>	2,0

1) In absence of other national regulations.

**alfa Iso - Universalanchor IUD****Annex 4**

Characteristic resistance

of European  
Technical Approval  
ETA-05/...

Table 5. Minimum anchor spacing, edge distance and thickness of base material

Anchor type		alfa IUD
Minimum spacing	$5 \cdot z$ [mm]	100
Minimum edge distance	$5 \cdot z$ [mm]	100
Minimum thickness of base material	$h \geq z$ [mm]	100

Schematic illustration of spacing

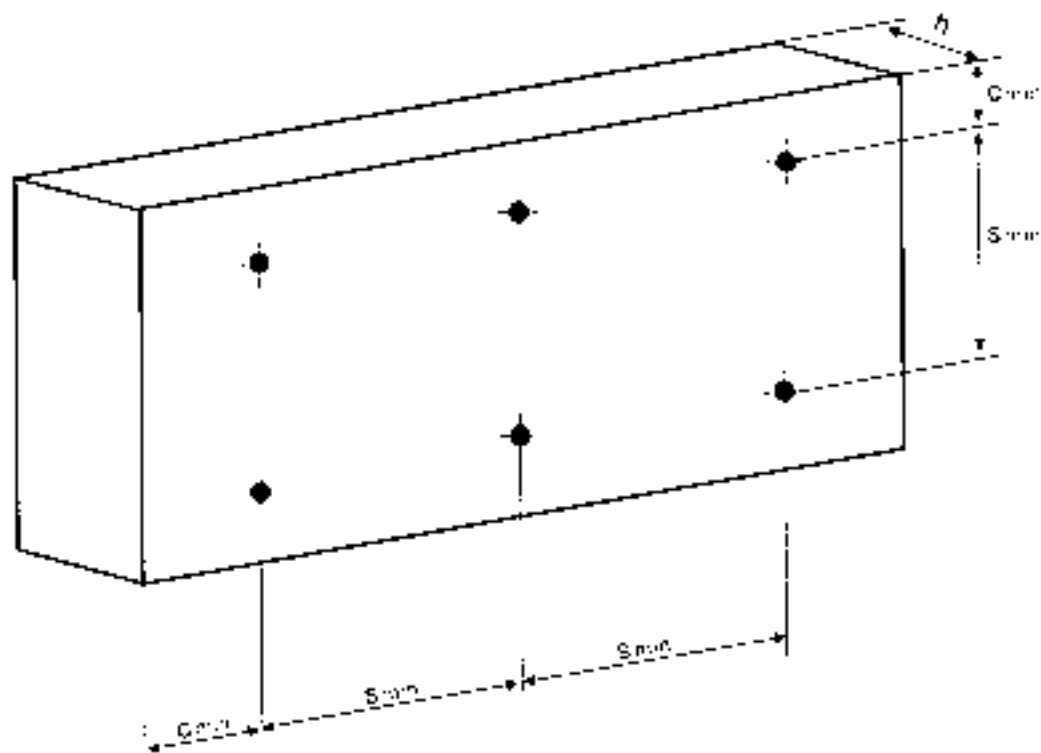

alfa Iso - Universalanchor IUD

Annex 5

Minimum anchor spacing, edge distance and  
thickness of base material

of European  
Technical Approval  
ETA-05.0267

Tabelle 6: Assignment type of anchor for lightweight concrete hollow blocks according to DIN 18151

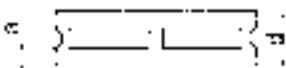
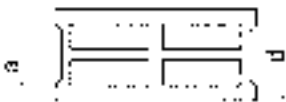
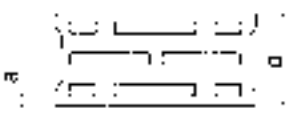
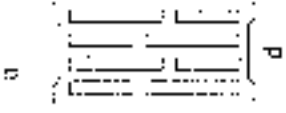
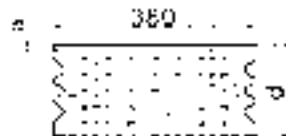
Contour	Thickness d [mm]	Outer web in longitudinal direction a [mm]	Anchor type alpha IUD	
	175	50	●	
	240 300	50	●	
	175	35	●	
	240 300 365	35	●	
		240 300 365	30	●
		Reference brick from ÖNORM B6124		●
380		250		

Anchor shall be placed in the brick in such way, that the spreading part of the expansion sleeve is located in the outer web

alpha Iso - Universalanchor IUD

Assignment type of anchor for  
lightweight concrete hollow blocks  
reference brick from ÖNORM B6124

Annex 6

of European  
Technical Approval  
ETA-05-0267

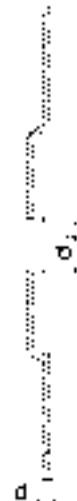
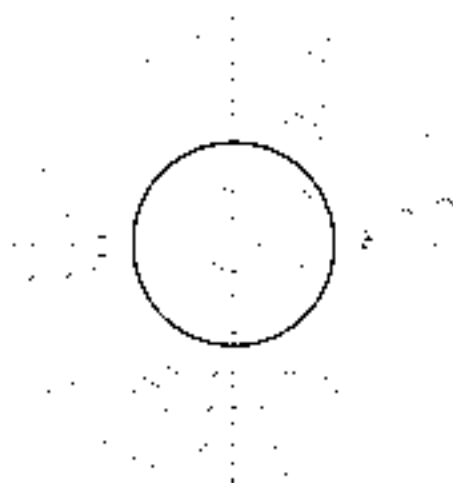

IUS 140	
colour	natural
$d_0$ [mm]	20.0
$d$ [mm]	3.0
material	1)

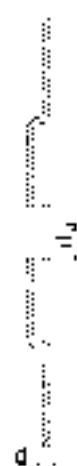
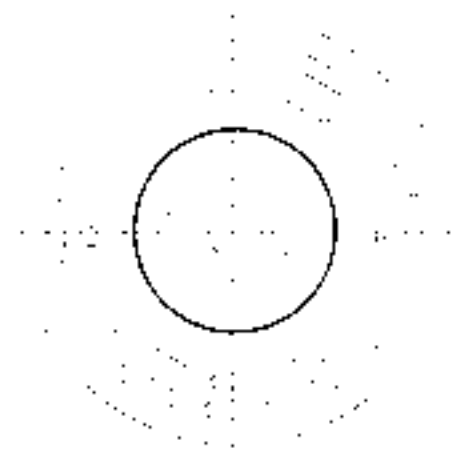

IUS 110	
colour	natural
$d_0$ [mm]	20.0
$d$ [mm]	2.5
material	1)

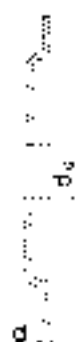
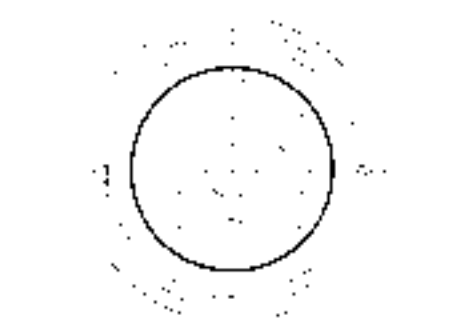

IUS 90	
colour	natural
$d_0$ [mm]	20.0
$d$ [mm]	2.5
material	1)

1) Polyethylene  
Hestalec GF 4752

alfa Iso - Universalanchor IUD

Anchor plate in combination  
with alfa IUD

Annex 7

of the European  
Technical Approval

ETA-05/0267